

Bảng thông số sản phẩm

Thông số kỹ thuật



single function relay, Harmony
Timer Relays, 5A, 2CO, 0.1s..
100h, on delay, 24V AC

REXL2TMB7

Main

Range of product	Harmony Timer Relays
product or component type	Miniature timing relay
Fixing mode	Plug-in (socket)
Discrete output type	Relay
Contacts type and composition	2 C/O
Component name	REXL
time delay type	Power on-delay
time delay range	10...100 h 6...60 min 0.1...1 s 1...10 h 1...10 min 6...60 s 1...10 s
Width	21 mm

Complementary

Contacts material	Cadmium free
[Us] rated supply voltage	24 V AC 50/60 Hz
Voltage range	0.85...1.15 Us
[In] rated current	5 A AC
Repeat accuracy	+/- 0.5 %
Setting accuracy of time delay	10 % at full scale at 25 °C conforming to IEC 61812-1
Temperature drift	0.05 %/°C
maximum reset time	250 ms after time delay, on de-energisation 50 ms during time delay, on de-energisation
Voltage drift	+/- 0.2 %/V
Maximum switching capacity	4 x 5 A
maximum temporary permissible current	10 A for < 10 s
Minimum switching current	100 mA
Electrical durability	100000 cycles at 250 V AC resistive
Mechanical durability	10000000 cycles
maximum power consumption	1.7 VA
[U _i] rated insulation voltage	250 V conforming to IEC 255 Group C 250 V conforming to VDE 0010

Output overvoltage protection	2 J
Surge withstand	2 kV conforming to IEC 61000-4-5 level 3
Creepage distance	4 kV/3 conforming to IEC 60664-1
Local signalling	1 LED (red) for output in operation 1 LED (yellow) for power ON
Function available	A- Power on-delay relay-2 C/O
Control type	Without test button
Shape of pin	Flat
Number of functions	1
net weight	0.05 kg

Environment

Immunity to microbreaks	5 ms
Dielectric strength	2 kV for 1 mA/1 minute at 50 Hz conforming to IEC 60601-1 2 kV for 1 mA/1 minute at 50 Hz conforming to IEC 61812-1
Standards	EN 50081-2 IEC 61000-6-2 IEC 60601-2 IEC 61812-1 93/68/EEC 73/23/EEC 89/336/EEC IEC 60601-1
Product certifications	UL cUL
Ambient air temperature for operation	-20...60 °C
Ambient air temperature for storage	-40...70 °C
IP degree of protection	IP50 conforming to IEC 60529
Vibration resistance	0.35 mm (f= 10...55 Hz) conforming to IEC 60068-2-6
Relative humidity	95 % without condensation conforming to IEC 60068-2-6
Resistance to electrostatic discharge	6 kV in contact conforming to IEC 61000-4-2 level 3 8 kV in air conforming to IEC 61000-4-2 level 3
Resistance to electromagnetic fields	10 V/m conforming to IEC 61000-4-3 level 3
Resistance to fast transients	2 kV conforming to IEC 61000-4-4 level 3
Immunity to radioelectric fields	10 V (0.15...80 MHz) conforming to IEC 61000-4-6 level 3
Immunity to voltage dips	>= 95 % / 1 s conforming to IEC 61000-4-11 30 % / 10 ms conforming to IEC 61000-4-11 60 % / 100 ms conforming to IEC 61000-4-11
Disturbance radiated/conducted	Class B conforming to EN 55022 (EN 55011 group 1)

Packing Units

Unit Type of Package 1	PCE
Number of Units in Package 1	1
Package 1 Height	3.1 cm
Package 1 Width	3.1 cm
Package 1 Length	7.5 cm
Package 1 Weight	50.9 g

Unit Type of Package 2	S01
Number of Units in Package 2	48
Package 2 Height	15 cm
Package 2 Width	15 cm
Package 2 Length	40 cm
Package 2 Weight	2.66 kg

Contractual warranty

Warranty	18 months
-----------------	-----------

Bền vững

Nhãn **Green Premium™** là cam kết của Schneider Electric trong việc cung cấp sản phẩm với hiệu suất môi trường tốt nhất. Green Premium cam kết tuân thủ các quy định mới nhất, minh bạch về tác động môi trường, cũng như các sản phẩm tuần hoàn và CO₂ thấp.

Hướng dẫn đánh giá tính bền vững của sản phẩm là tài liệu kỹ thuật phổ thông giúp làm rõ các tiêu chuẩn nhãn sinh thái toàn cầu và cách diễn giải việc khai báo môi trường.

[Tìm hiểu thêm về Green Premium >](#)

[Hướng dẫn đánh giá về sự bền vững của sản phẩm >](#)



Minh bạch [RoHS/REACH](#)

Hiệu suất sức khỏe



Mercury Free



Rohs Exemption Information

[Yes](#)

Chứng nhận & Tiêu chuẩn

Reach Regulation

[REACH Declaration](#)

Eu Rohs Directive

Pro-active compliance (Product out of EU RoHS legal scope)

China Rohs Regulation

[China RoHS declaration](#)

Environmental Disclosure

[Product Environmental Profile](#)

Weee

The product must be disposed on European Union markets following specific waste collection and never end up in rubbish bins

Circularity Profile

No need of specific recycling operations

Bảng thông số sản phẩm

REXL2TMB7

Dimensions Drawings

Width 21 mm

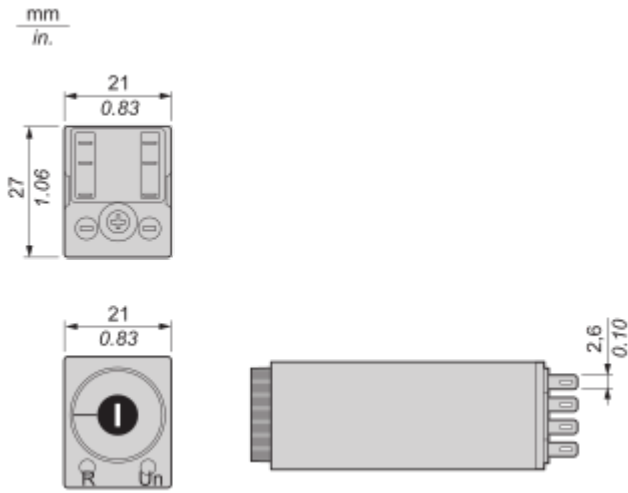

Connections and Schema

Terminal Referencing

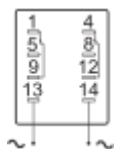

Technical Description



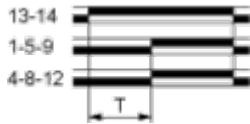

Function A : Power on Delay Relay

Description

The timing period T begins on energisation. After timing, the outputs close.
2 Timed C/O Contacts



Legend

-  Relay de-energised
-  Relay energised
-  Output open
-  Output closed

R	Relay output
T	Timing period